

3.0W Surface Mount Zener Diodes - 6.8V-200V

Features

- Batch process design, excellent power dissipation offers better reverse leakage current and thermal resistance.
- Glass passivated chip junction.
- Typical IR less than 0.5 μ A above 200V.
- Standard zener voltage tolerance \pm 5%.
- Low inductance.
- Low profile package.
- Built-in strain relief.
- Lead-free parts meet environmental standards of MIL-STD-19500/228
- Suffix "-H" indicates Halogen free parts, ex. 1SMB3V6.8BG-H.

Mechanical data

- Epoxy:UL94-V0 rated flame retardant
- Case : Molded plastic, DO-214AA/SMB
- Terminals :Plated terminals, solderable per MIL-STD-750, Method 2026
- Polarity : Indicated by cathode band
- Mounting Position : Any
- Weight :Approximated 0.09 gram

Maximum ratings (AT $T_A=25^{\circ}\text{C}$ unless otherwise noted)

PARAMETER	CONDITIONS	Symbol	MIN.	TYP.	MAX.	UNIT
Forward voltage	$I_F = 200 \text{ mAdc}$	V_F			1.20	V
Power Dissipation	$T_L=50^{\circ}\text{C}$ (Note 1)	P_D			3.0	W
Forward surge current	8.3ms single half sine-wave superimposed on rate load (JEDEC methode)	I_{FSM}			15	A
Operating temperature		T_J	-55		+150	$^{\circ}\text{C}$
Storage temperature		T_{STG}	-65		+175	$^{\circ}\text{C}$

Note.1 Mounted on 11 x 11mm FR-4 or FR-5 Board

Thermal haracteristics

PARAMETER	Symbol	Limit	UNIT
Typical thermal resistance junction to ambient	$R_{\theta JA}$	85	$^{\circ}\text{C/W}$

Package outline

SMB

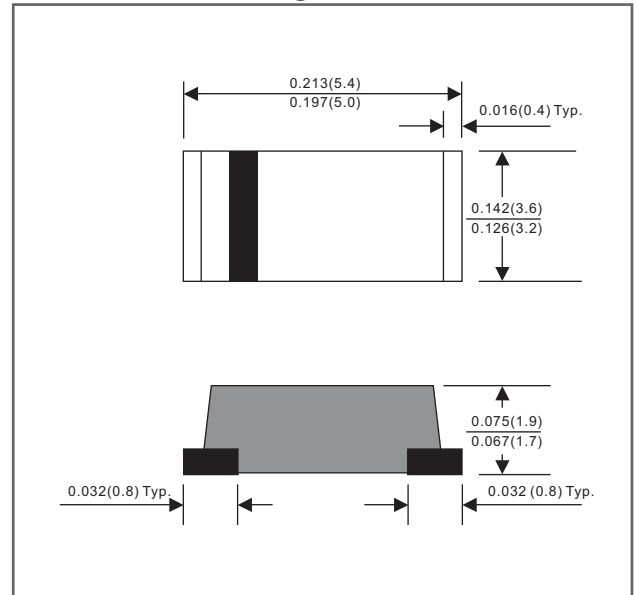

Dimensions in inches and (millimeters)



1SMB3V6.8BG THRU 1SMB3V200BG

Electrical characteristics (at $T_A=25^\circ\text{C}$ unless otherwise noted)

Part No.	Zener voltage			Test current	Zener impedance			Leakage current	
	$V_Z @ I_{ZT}(\text{Volts})$			I_{ZT}	$Z_{ZT} @ I_{ZT}$	$Z_{ZK} @ I_{ZK}$	I_{ZK}	I_R	V_R
	Min.	Nom.	Max.	mA	Max. (Ω)	Max. (Ω)	mA	Max. (μA)	Volts
1SMB3V6.8BG	6.46	6.8	7.14	110	2.0	700	1.00	5.0	4.0
1SMB3V7.5BG	7.13	7.5	7.88	100	2.0	700	0.50	5.0	5.0
1SMB3V8.2BG	7.79	8.2	8.61	91	2.0	700	0.50	5.0	6.0
1SMB3V8.7BG	8.27	8.7	9.14	85	2.0	700	0.50	4.0	6.6
1SMB3V9.1BG	8.65	9.1	9.56	82	3.0	700	0.50	3.0	7.0
1SMB3V10BG	9.50	10	10.50	75	4.0	700	0.50	3.0	7.6
1SMB3V11BG	10.45	11	11.55	68	4.0	700	0.25	1.0	8.4
1SMB3V12BG	11.40	12	12.60	63	4.5	700	0.25	1.0	9.1
1SMB3V13BG	12.35	13	13.65	58	5.0	700	0.25	0.5	9.9
1SMB3V15BG	14.25	15	15.75	50	7.0	700	0.25	0.5	11.4
1SMB3V16BG	15.20	16	16.80	47	8.0	700	0.25	0.5	12.2
1SMB3V18BG	17.10	18	18.90	42	10.0	750	0.25	0.5	13.7
1SMB3V20BG	19.00	20	21.00	37	11.0	750	0.25	0.5	15.2
1SMB3V22BG	20.90	22	23.10	34	12.0	750	0.25	0.5	16.7
1SMB3V24BG	22.80	24	25.20	31	13.0	750	0.25	0.5	18.2
1SMB3V27BG	25.65	27	28.35	28	18.0	750	0.25	0.5	20.6
1SMB3V30BG	28.50	30	31.50	25	20.0	1000	0.25	0.5	22.8
1SMB3V33BG	31.35	33	34.65	23	23.0	1000	0.25	0.5	25.4
1SMB3V36BG	34.20	36	37.80	21	25.0	1000	0.25	0.5	27.4
1SMB3V39BG	37.05	39	40.95	19	30.0	1500	0.25	0.5	29.7
1SMB3V43BG	40.85	43	45.15	17	35.0	1500	0.25	0.5	32.7
1SMB3V47BG	44.65	47	49.35	16	40.0	1500	0.25	0.5	35.8
1SMB3V51BG	48.45	51	53.55	15	48.0	1500	0.25	0.5	38.8
1SMB3V56BG	53.20	56	58.80	13	55.0	2000	0.25	0.5	42.6
1SMB3V62BG	58.90	62	65.10	12	60.0	2000	0.25	0.5	47.1
1SMB3V68BG	64.60	68	71.40	11	75.0	2000	0.25	0.5	51.7
1SMB3V75BG	71.25	75	78.75	10	90.0	2000	0.25	0.5	56.0
1SMB3V82BG	77.90	82	86.10	9.1	100	3000	0.25	0.5	62.2
1SMB3V91BG	86.45	91	95.55	8.2	125	3000	0.25	0.5	69.2
1SMB3V100BG	95.00	100	105.0	7.5	175	3000	0.25	0.5	76.0
1SMB3V110BG	104.50	110	115.5	6.8	250	4000	0.25	0.5	83.6
1SMB3V120BG	114.00	120	126.0	6.3	325	4500	0.25	0.5	91.2
1SMB3V130BG	123.50	130	136.5	5.8	400	5000	0.25	0.5	98.8
1SMB3V150BG	142.50	150	157.5	5.0	575	6000	0.25	0.5	114.0
1SMB3V160BG	152.00	160	168.0	4.7	650	6500	0.25	0.5	121.6
1SMB3V180BG	171.00	180	189.0	4.2	725	7000	0.25	0.5	136.8
1SMB3V200BG	190.00	200	210.0	3.7	900	8000	0.25	0.5	152.0

Note : 20% tolerance of Zener voltage for no suffix ex: 1SMB3V6.8 is 6.8V 20%
 10% tolerance of Zener voltage for suffix "A" ex: 1SMB3V6.8A is 6.8V 10%
 5% tolerance of Zener voltage for suffix "B" ex: 1SMB3V6.8B is 6.8V 5%
 2% tolerance of Zener voltage for suffix "C" ex: 1SMB3V6.8C is 6.8V 2%



Rating and characteristic curves

FIG.1 Typical Thermal Response L

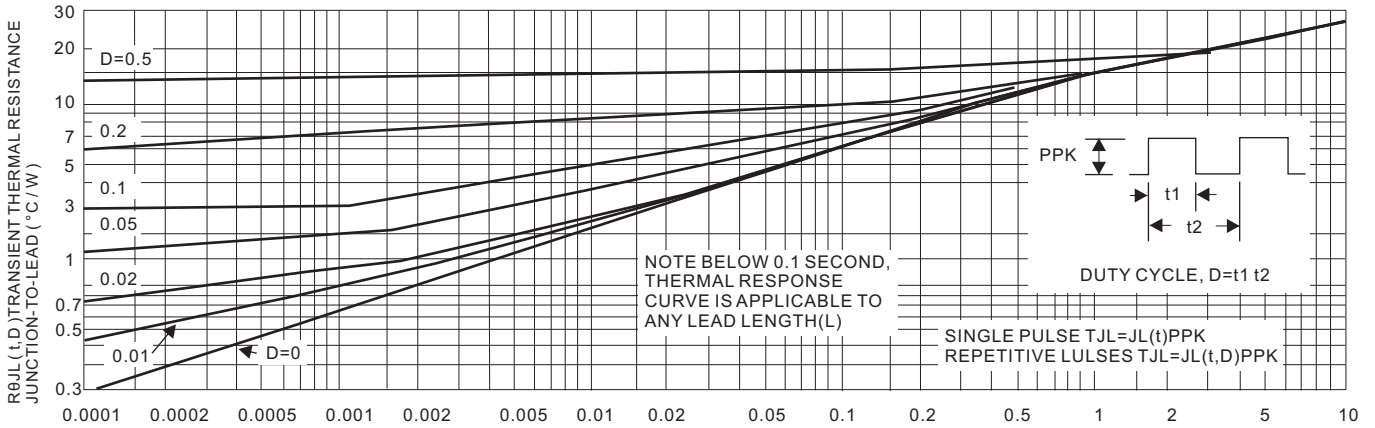

FIG. 2 Maximum Surge Power

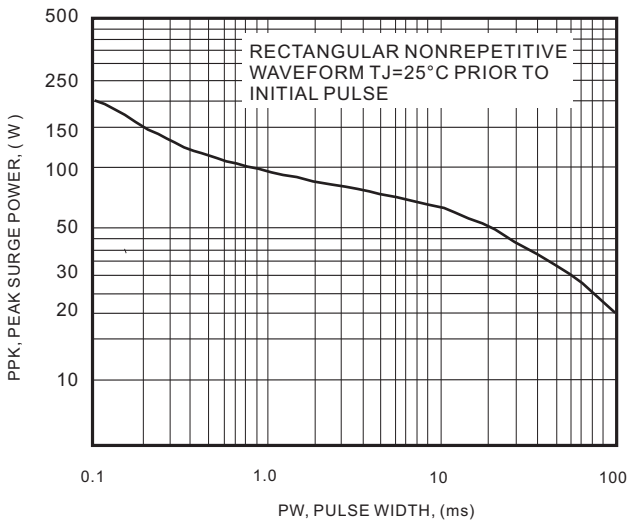

FIG. 3 Maximum Surge Power

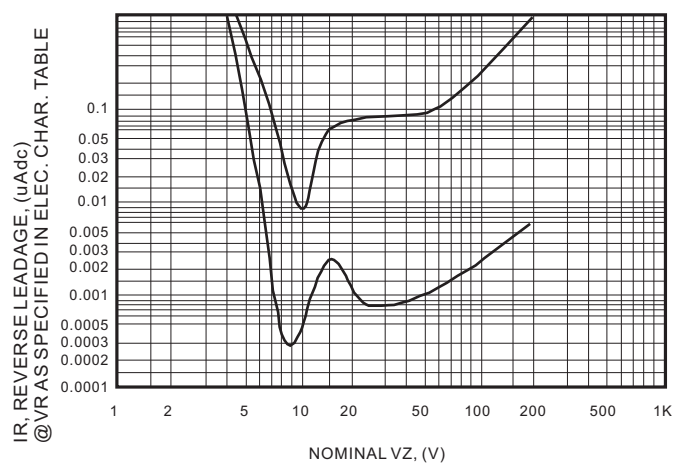

FIG.4 Units To 12 Volts

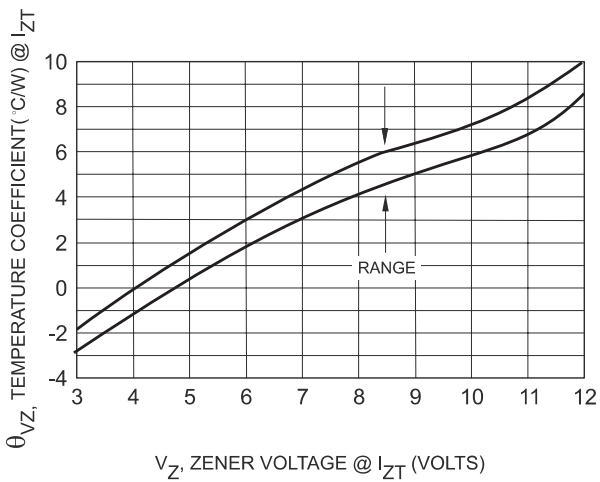
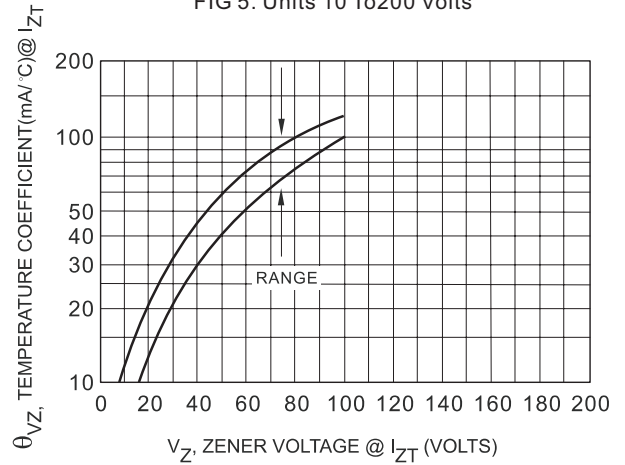

FIG 5. Units 10 To 200 Volts



Rating and characteristic curves

FIG.6 VZ = 3.9 Thru 10 Volts

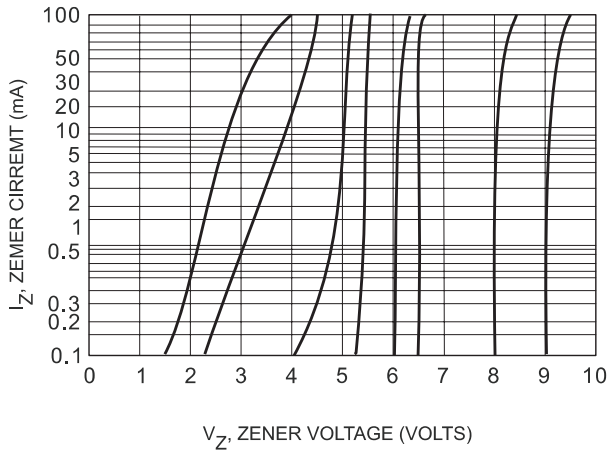

FIG.7 VZ = 12 Thru 82 Volts

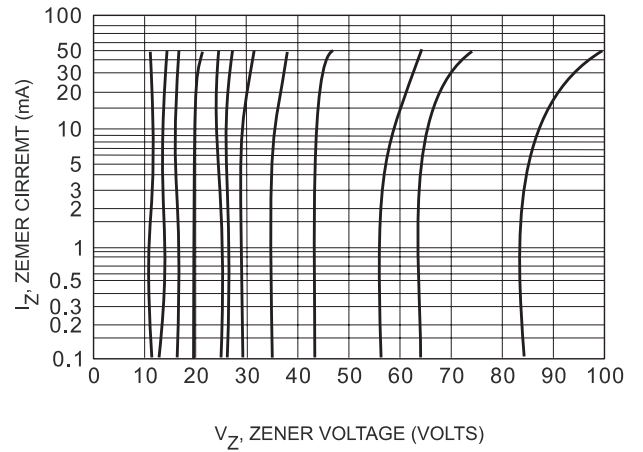

FIG. 8 Typical Thermal Resistance

