



1SMB2V6.8BG THRU 1SMB2V200BG

Chip Zener Diode

2.0W Surface Mount Zener Diodes - 6.8V-200V

Features

- Batch process design, excellent power dissipation offers better reverse leakage current and thermal resistance.
- Glass passivated chip junction.
- Typical IR less than 0.5 μ A above 200V.
- Standard zener voltage tolerance \pm 5%.
- Low inductance.
- Low profile package.
- Built-in strain relief.
- Lead-free parts meet environmental standards of MIL-STD-19500/228
- Suffix "-H" indicates Halogen free parts, ex. 1SMB2V6.8BG-H.

Mechanical data

- Epoxy:UL94-V0 rated flame retardant
- Case : Molded plastic, DO-214AA/SMB
- Terminals :Plated terminals, solderable per MIL-STD-750, Method 2026
- Polarity : Indicated by cathode band
- Mounting Position : Any
- Weight :Approximated 0.09 gram

Maximum ratings (AT $T_A=25^{\circ}\text{C}$ unless otherwise noted)

PARAMETER	CONDITIONS	Symbol	MIN.	TYP.	MAX.	UNIT
Forward voltage	$I_F = 200 \text{ mA DC}$	V_F			1.20	V
Power Dissipation		P_D			2.0	W
Forward surge current	8.3ms single half sine-wave superimposed on rate load (JEDEC methode)	I_{FSM}			15	A
Operating temperature		T_J	-55		+150	$^{\circ}\text{C}$
Storage temperature		T_{STG}	-65		+175	$^{\circ}\text{C}$

Package outline

SMB

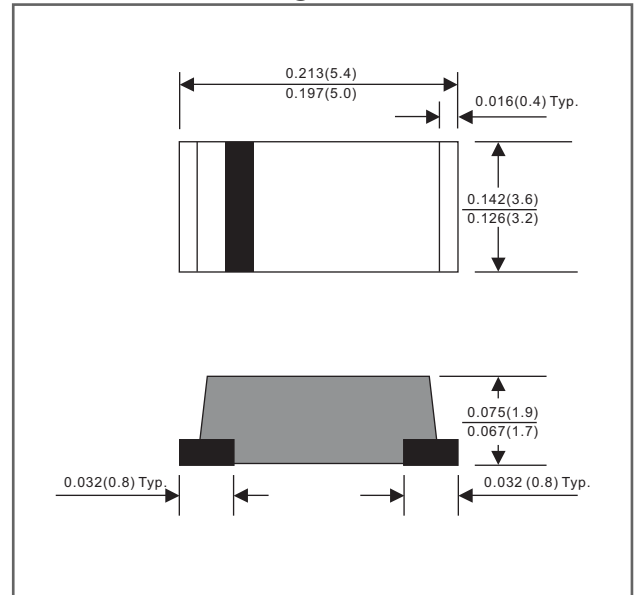

Dimensions in inches and (millimeters)



1SMB2V6.8BG THRU 1SMB2V200BG

Electrical characteristics (at T_A=25°C unless otherwise noted)

Part No.	Zener voltage			Test current	Zener impedance			Leakage current	
	V _Z @ I _{ZT} (Volts)			I _{ZT}	Z _{ZT} @ I _{ZT}	Z _{ZK} @ I _{ZK}	I _{ZK}	I _R	V _R
	Min.	Nom.	Max.	mA	OHMs	OHMs	mA	uA	Volts
1SMB2V6.8BG	6.46	6.8	7.14	73.5	2.0	700	1.00	5.0	4.0
1SMB2V7.5BG	7.13	7.5	7.88	66.5	2.0	700	0.50	5.0	5.0
1SMB2V8.2BG	7.79	8.2	8.61	61	2.0	700	0.50	5.0	6.0
1SMB2V8.7BG	8.27	8.7	9.14	58	2.0	700	0.50	4.0	6.6
1SMB2V9.1BG	8.65	9.1	9.56	55	3.0	700	0.50	3.0	7.0
1SMB2V10BG	9.50	10	10.50	50	4.0	700	0.50	3.0	7.6
1SMB2V11BG	10.45	11	11.55	45.5	4.0	700	0.25	1.0	8.4
1SMB2V12BG	11.40	12	12.60	41.5	4.5	700	0.25	1.0	9.1
1SMB2V13BG	12.35	13	13.65	38.5	5.0	700	0.25	0.5	9.9
1SMB2V15BG	14.25	15	15.75	33.4	7.0	700	0.25	0.5	11.4
1SMB2V16BG	15.20	16	16.80	31.2	8.0	700	0.25	0.5	12.2
1SMB2V18BG	17.10	18	18.90	27.8	10.0	750	0.25	0.5	13.7
1SMB2V20BG	19.00	20	21.00	25.0	11.0	750	0.25	0.5	15.2
1SMB2V22BG	20.90	22	23.10	22.8	12.0	750	0.25	0.5	16.7
1SMB2V24BG	22.80	24	25.20	20.8	13.0	750	0.25	0.5	18.2
1SMB2V27BG	25.65	27	28.35	18.5	18.0	750	0.25	0.5	20.6
1SMB2V30BG	28.50	30	31.50	16.6	20.0	1000	0.25	0.5	22.8
1SMB2V33BG	31.35	33	34.65	15.1	23.0	1000	0.25	0.5	25.4
1SMB2V36BG	34.20	36	37.80	13.9	25.0	1000	0.25	0.5	27.4
1SMB2V39BG	37.05	39	40.95	12.8	30.0	1500	0.25	0.5	29.7
1SMB2V43BG	40.85	43	45.15	11.6	35.0	1500	0.25	0.5	32.7
1SMB2V47BG	44.65	47	49.35	10.6	40.0	1500	0.25	0.5	35.8
1SMB2V51BG	48.45	51	53.55	9.8	48.0	1500	0.25	0.5	38.8
1SMB2V56BG	53.20	56	58.80	9.0	55.0	2000	0.25	0.5	42.6
1SMB2V62BG	58.90	62	65.10	8.1	60.0	2000	0.25	0.5	47.1
1SMB2V68BG	64.60	68	71.40	7.4	75.0	2000	0.25	0.5	51.7
1SMB2V75BG	71.25	75	78.75	6.7	90.0	2000	0.25	0.5	56.0
1SMB2V82BG	77.90	82	86.10	6.1	100	3000	0.25	0.5	62.2
1SMB2V91BG	86.45	91	95.55	5.5	125	3000	0.25	0.5	69.2
1SMB2V100BG	95.00	100	105.0	5.0	175	3000	0.25	0.5	76.0
1SMB2V110BG	104.50	110	115.5	4.5	250	4000	0.25	0.5	83.6
1SMB2V120BG	114.00	120	126.0	4.2	325	4500	0.25	0.5	91.2
1SMB2V130BG	123.50	130	136.5	3.8	400	5000	0.25	0.5	98.8
1SMB2V150BG	142.50	150	157.5	3.3	575	6000	0.25	0.5	114.0
1SMB2V160BG	152.00	160	168.0	3.1	650	6500	0.25	0.5	121.6
1SMB2V180BG	171.00	180	189.0	2.8	725	7000	0.25	0.5	136.8
1SMB2V200BG	190.00	200	210.0	2.5	900	8000	0.25	0.5	152.0

Note : 20% tolerance of Zener voltage for no suffix ex: 1SMB2V6.8 is 6.8V 20%
10% tolerance of Zener voltage for suffix "A" ex: 1SMB2V6.8A is 6.8V 10%
5% tolerance of Zener voltage for suffix "B" ex: 1SMB2V6.8B is 6.8V 5%
2% tolerance of Zener voltage for suffix "C" ex: 1SMB2V6.8C is 6.8V 2%



Rating and characteristic curves

FIG.1 Typical Thermal Response L

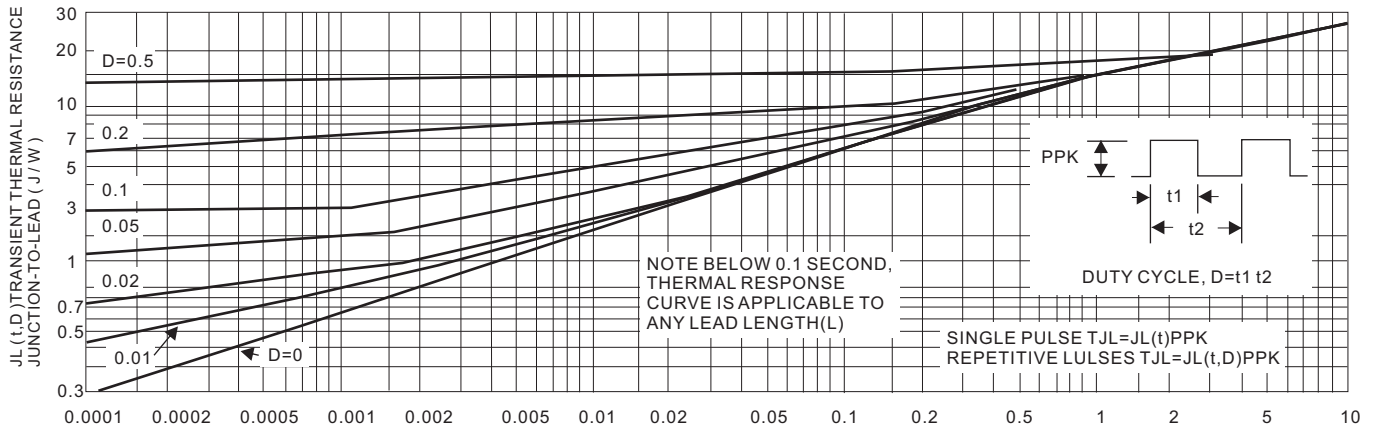

Fig. 2 Maximum Surge Power

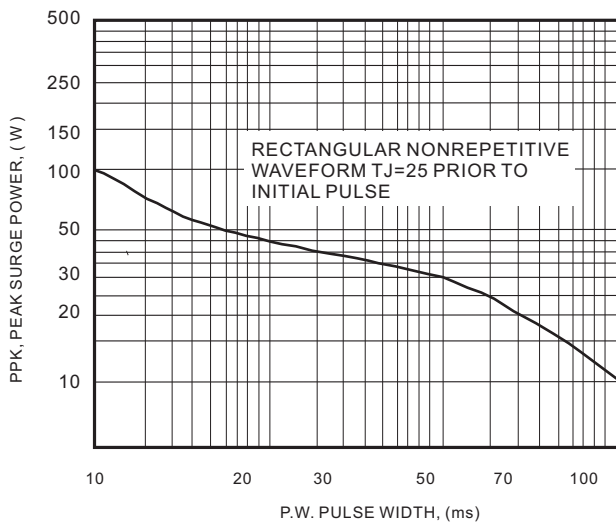

Fig. 3 Maximum Surge Power

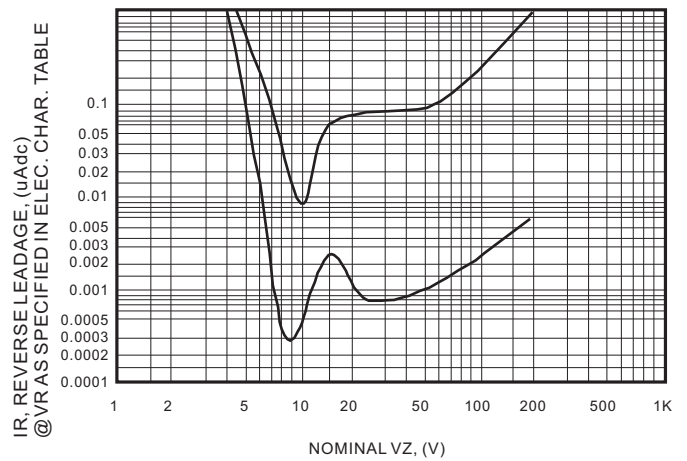

FIG.4 Units To 12 Volts

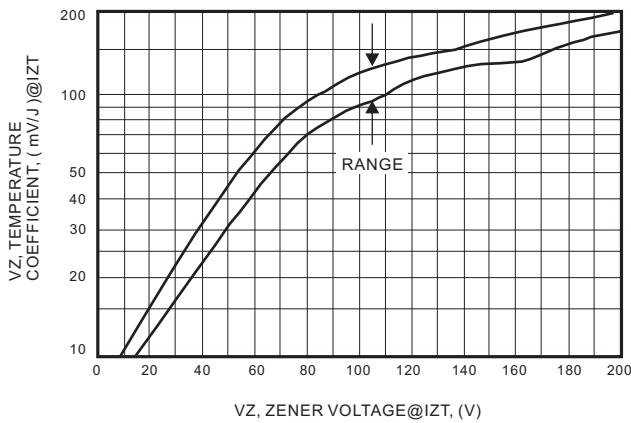
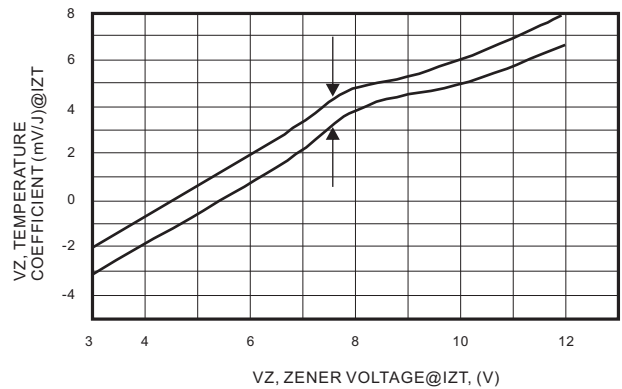

Fig 5. Units 10 To 200 Volts



Rating and characteristic curves

FIG.6 VZ = 3.9 Thru 10 Volts

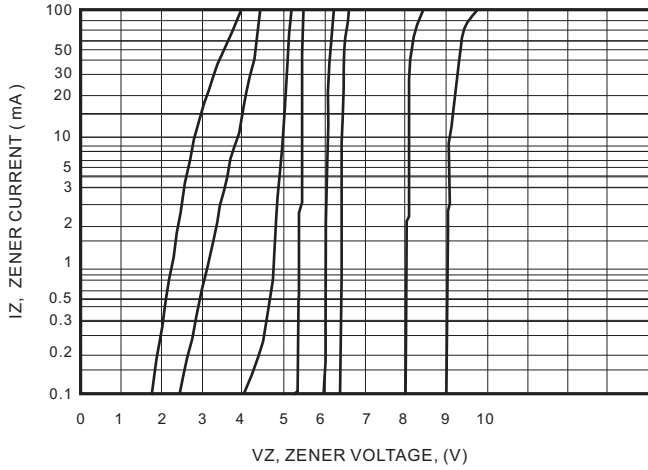

FIG.7 VZ = 12 Thru 82 Volts

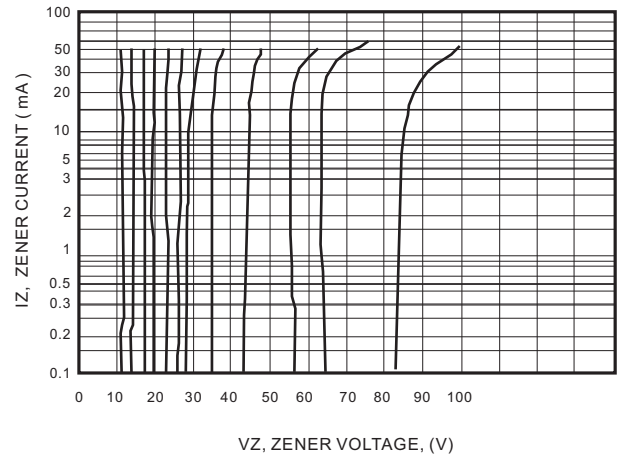

Fig. 8 VZ = 100 Thru 200 Volts

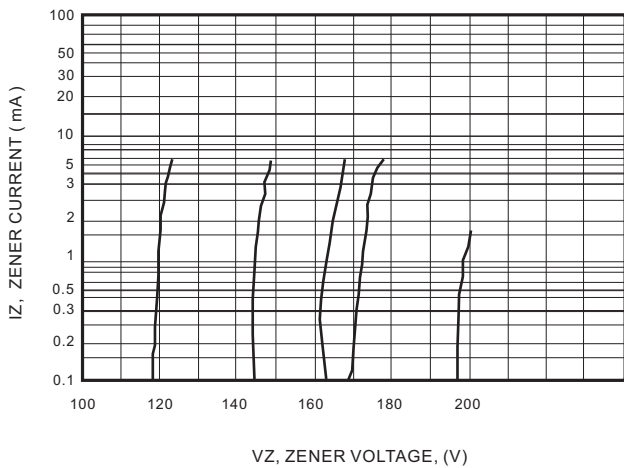

Fig. 9 Typical Thermal Resistance

